

Varenummer: 0109057  
 Beskrivelse: Seeger låsering AS 40X2.5  
 Fjederstål  
 Note: Monteres med ZGA tang

## Mål

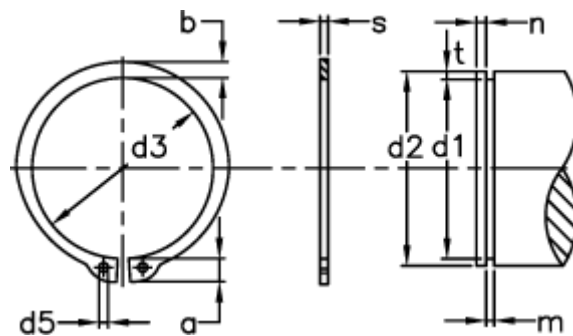

a max	= 7.0	d5 min	= 2.5	s	= 2.50
AN mm <sup>2</sup>	= 152.0	FN kN	= 25.30	t	= 1.25
B	= 2.04	FRg kN	= 19.3	Tang	= ZGA-3
b	= 4.4	FR kN	= 104.0	tol	= -0.07
Betegnelse	= AS 40	g	= 2.0	tol	= +0,39 -0,90
d1	= 37.5	m min	= 2.65	tol	= -0.25
d2	= 40	n abl x 1000	= 14	vægt kg/1000	= 8.20
d3	= 36.5	Nominel træk	= 3.8		